

Shown are typical construction details for single units. These are solely used for the purpose of visualizing a window/door in a wall detail.

Proper Installation System Objectives:

- Minimize water and air infiltration
- Allow for expansion and contraction around unit
- Attach unit securely to wall

The design and structural load requirements of the rough opening are to be determined and met by the architect and/or engineer. Window/Door frame systems are not designed to support additional elements or components of the building wall system.

General Notes

- Details reflect various wall systems. Other Weather Shield® products in the same wall construction will reflect similarly.
- Details do not reflect complete installation procedures.
- Refer to the Installation Guides under the Resources tab on www.weathershield.com for step by step procedures to install properly.
- Weather Shield® sales representatives can assist with other variable applications.

Installation Methods

Integrated Nailing Fins, Installation Clips and Frame Screws are the most common methods for installing Weather Shield Premium Series® Windows and Doors.

- Integrated Nailing Fins: applicable in most situations where the window/door can be installed from the exterior of the house to the sheathing. Primarily used on wood, vinyl, stucco (new construction) and brick veneer (new construction) exteriors.
- Installation Clips: applicable in situations where the window/door needs to be installed and fastened in the interior. Primarily used on reconstruction.
- Frame Screws: applicable in both installing the window/door from the interior or exterior. Mostly used when the window/door needs to be fastened to a wood buck, usually with concrete or masonry wall systems.

Important Installation Procedures

- Unit must be shimmed in the opening, true, plum, level and square. Shim windows a minimum of 1/4" above sill plate to provide proper clearance.
- Shims are required to keep frames straight.
- When insulating around the unit, use batt insulation or window and door installation foam. Do not use high compressive foam.

IMPORTANT! Details are shown with minimal spacing between items for clarity of illustration. Actual assembly details may vary.

Weather Shield™

Premium Series

Casement Windows

BRICK VENEER INSTALLATION DETAILS

Brick Veneer Exterior - Concrete Block 10-3/4" Jamb - Jamb Extension

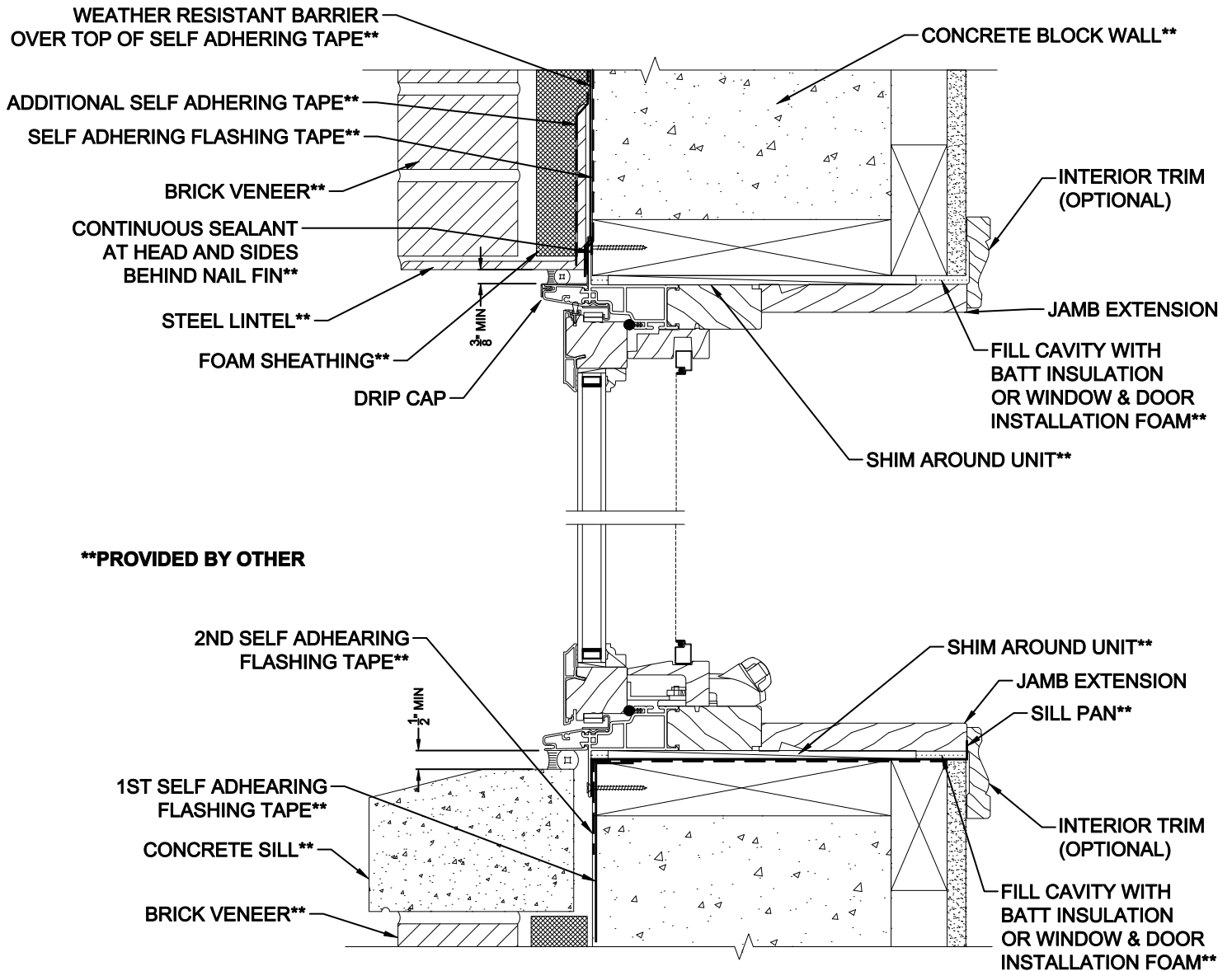

Note: All dimensions are approximate. Weather Shield reserves the right to change specifications without notice.

Weather Shield™

Premium Series

Casement Windows

BRICK VENEER INSTALLATION DETAILS

Brick Veneer Exterior - Concrete Block 10-3/4" Jamb - Jamb Extension

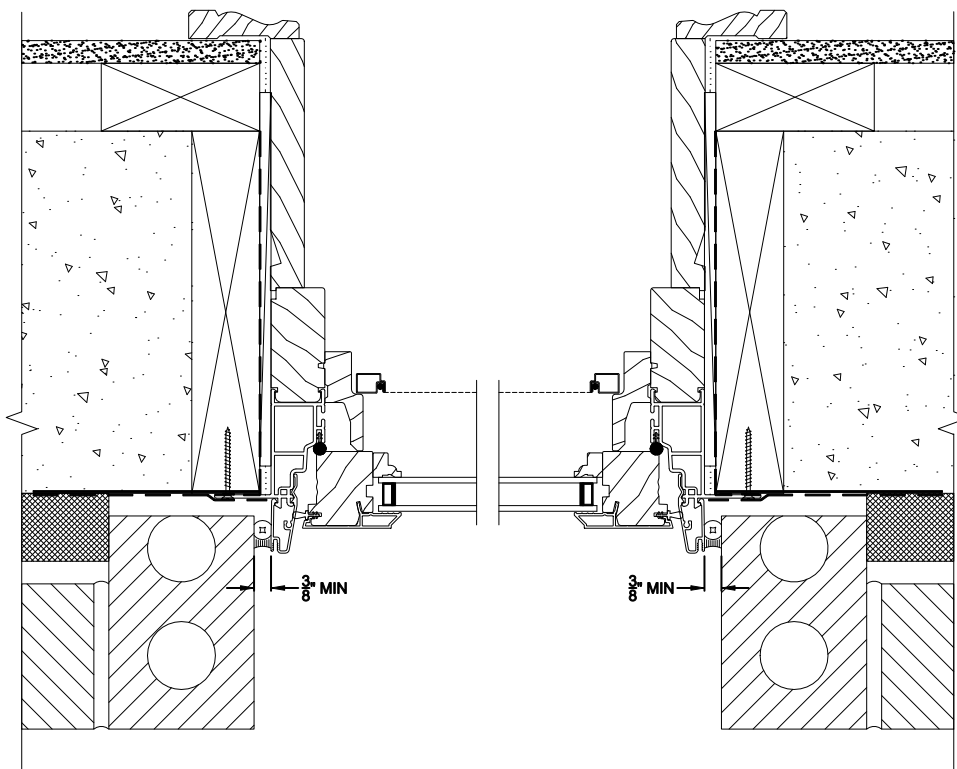

Note: All dimensions are approximate. Weather Shield reserves the right to change specifications without notice.

Weather Shield™

Premium Series

Casement Windows

BRICK VENEER INSTALLATION DETAILS

Brick Veneer Exterior - Concrete Block 10-3/4" Jamb - Drywall Return

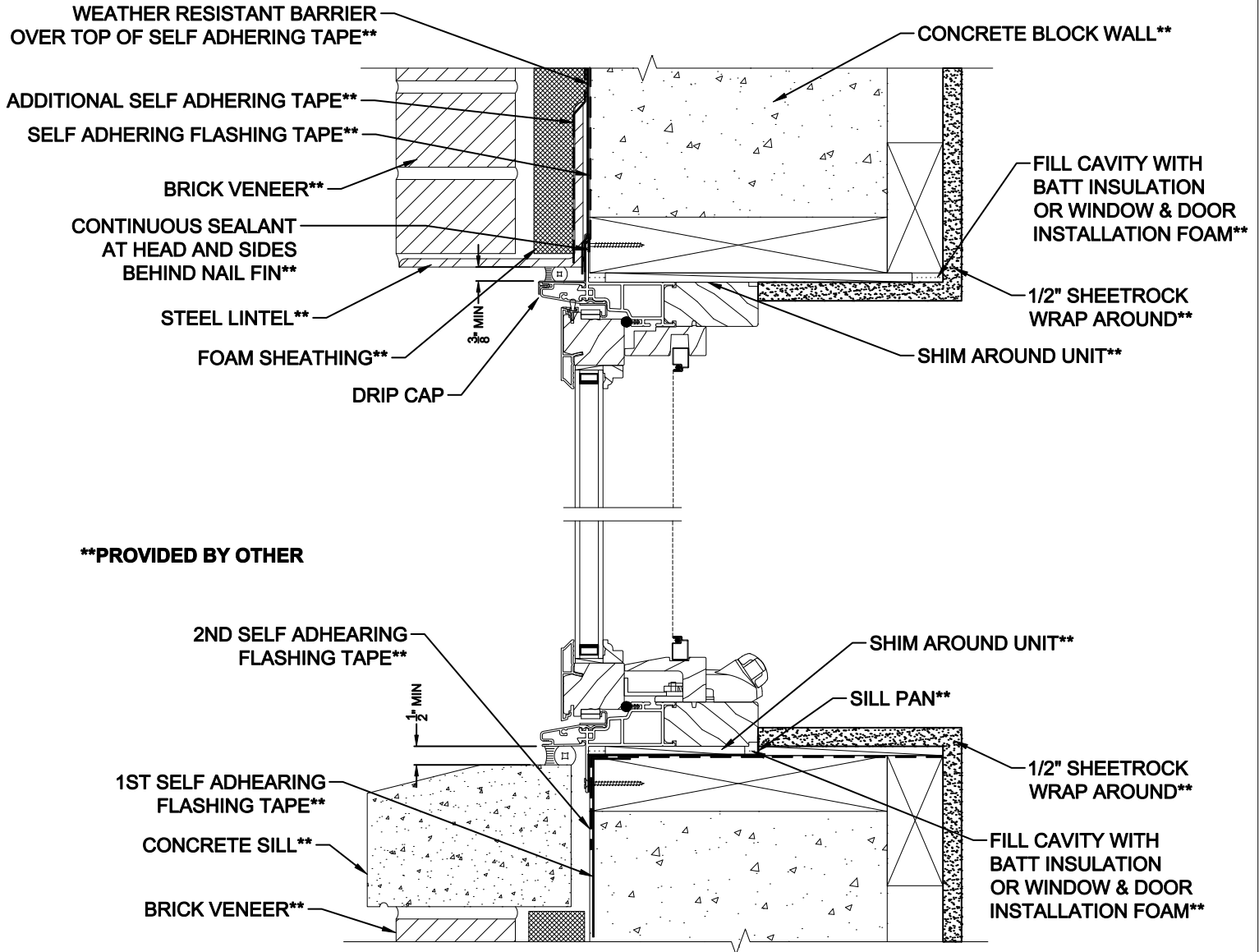

Note: All dimensions are approximate. Weather Shield reserves the right to change specifications without notice.

Weather Shield™

Premium Series

Casement Windows

BRICK VENEER INSTALLATION DETAILS

Brick Veneer Exterior - Concrete Block 10-3/4" Jamb - Drywall Return

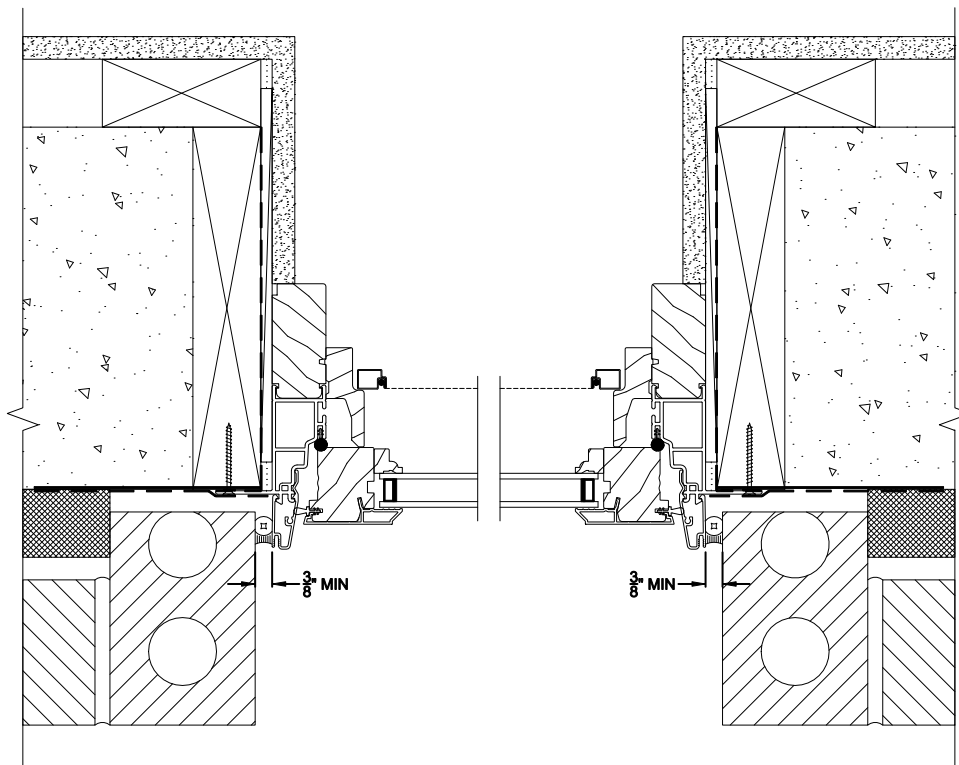

Note: All dimensions are approximate. Weather Shield reserves the right to change specifications without notice.